



# 2015 CATALOG

ACCESSORIES AND UPGRADES FOR JEEP® ENTHUSIASTS





**www.rtoffroad.com**

**Crown Automotive Sales Co., Inc. / RT Off-Road is not affiliated with FCA US, LLC. Jeep® is a registered trademark of FCA US, LLC.**

Wrangler,<sup>™</sup> Cherokee,<sup>™</sup> Wagoneer,<sup>™</sup> Grand Wagoneer,<sup>™</sup> Liberty,<sup>™</sup> Commander,<sup>™</sup> Comanche,<sup>™</sup> Compass,<sup>™</sup> Patriot,<sup>™</sup> and Grand Cherokee<sup>™</sup> are trademarks of FCA US, LLC.

Some part numbers listed in this catalog are used for reference purposes only. No implication is made that the actual products sold are the product of the original equipment manufacturer.

Reference to a manufacturer in the catalog does not indicate that the manufacturer is the source or sponsor of the listed product. All products listed in this catalog are being sold without any sponsorship or approval of any auto manufacturer.

Copyright © 2015 Crown Automotive Sales Company Inc. All rights reserved.

**MA 1-800-343-9666 • GA 1-800-241-9462 • NV 1-800-453-8220**

• TABLE OF CONTENTS •

<b>Soft Tops, Covers &amp; Top/Door Hardware</b>	<b>6–25</b>
<b>Seat Covers</b>	<b>26–29</b>
<b>Steel Bumpers &amp; Body Armor</b>	<b>30–37</b>
<b>Suspension</b>	<b>38–47</b>
<b>Steering</b>	<b>48–51</b>
<b>Drivetrain</b>	<b>52–61</b>
<b>Brakes</b>	<b>62–67</b>
<b>Lighting</b>	<b>68–75</b>
<b>Wheel Spacers/Adapters</b>	<b>76–77</b>
<b>Exterior Accessories</b>	<b>78–79</b>
<b>Interior Accessories</b>	<b>80–85</b>
<b>Stainless &amp; Related Accessories</b>	<b>86–111</b>
<b>Engine</b>	<b>112–115</b>



## FEATURED NEW ITEMS

### HD DIFFERENTIAL COVERS



More Info on page 54

### DOOR SURROUND KITS



More Info on Page 21

### HOOD CATCH KITS



More Info on Page 100

## FEATURED NEW ITEMS

### LED LIGHTS



More Info on Page 72

### LED BULBS



More Info on Page 74

### QUICK RELEASE MIRROR SETS



More Info on Page 109

## COMPLETE TOPS

RT Off-Road's Complete Soft Tops are complete top packages that include everything needed to install them. Kits include: Soft Top, Windows (where applicable), Bow Assembly, and all hardware. Each top also includes soft top disconnects, a soft top storage bag, and storage pockets built into the top itself. The improved frame design and bow assembly increase ease of use and is able to fold down when not in use.



Black  
Denim



Gray  
Denim



Spice  
Denim



Khaki  
Diamond



Black  
Diamond



**Black Denim**

Model	Year	Tinted Windows	Door Type	Part #
YJ	88/95	No	Half	CT20015
YJ	88/95	Yes	Half	CT20015T

**Gray Denim**

Model	Year	Tinted Windows	Door Type	Part #
YJ	88/95	No	Half	CT20009
YJ	88/95	Yes	Half	CT20009T

**Spice Denim**

Model	Year	Tinted Windows	Door Type	Part #
TJ	97/06	No	Half	CT20137
TJ	97/06	Yes	Half	CT20237T
TJ	97/06	No	Full	CT20337
TJ	97/06	Yes	Full	CT20437T
YJ	88/95	No	Half	CT20037
YJ	88/95	Yes	Half	CT20037T

**Black Diamond**

Model	Year	Tinted Windows	Door Type	Part #
TJ	97/06	No	Half	CT20135
TJ	97/06	Yes	Half	CT20235T
TJ	97/06	No	Full	CT20335
TJ	97/06	Yes	Full	CT20435T
YJ	87/95	Yes	Full	CT20035T
CJ-7	76/86	Yes	Full	CT20035T

**Khaki Diamond**

Model	Year	Tinted Windows	Door Type	Part #
TJ	97/06	No	Half	CT20136
TJ	97/06	Yes	Half	CT20236T
TJ	97/06	No	Full	CT20336
TJ	97/06	Yes	Full	CT20436T

## OEM STYLE SOFT TOPS

RT Off-Road's OEM Style Replacement Soft Tops are a perfect way of replacing a worn and drafty top with foggy windows and broken zippers. This direct replacement top includes cloth and either clear or tinted windows. Factory frames and hardware must be reused.

### Fabric Top With Half Doors

Model	Year	Tinted Windows	Color	Part #
JK 2DR	07/09	Yes	Black Diamond	RT10535T
JK 4DR	07/09	Yes	Black Diamond	RT10635T
TJ	97/06	Yes	Black Denim	RT10115T
TJ	97/06	No	Black Denim	RT10315
TJ	97/06	Yes	Black Diamond	RT10335T
TJ	97/06	No	Black Diamond	RT10335
TJ	97/06	No	Khaki Diamond	RT10336
TJ	97/06	No	Spice	RT10337
TJ	97/06	Yes	Spice	RT10337T
YJ	88/95	No	Spice	RT10037 *
YJ	88/95	No	Gray	RT10009
YJ	88/95	Yes	Black Denim	RT10015T
YJ	88/95	No	Black Denim	RT10015

\*1987 YJ Wrangler half door upper door skins are not available.

### Fabric Top For Use With Full Steel Doors

Model	Year	Tinted Windows	Color	Part #
TJ	97/06	Yes	Black Denim	RT10215T
TJ	97/06	Yes	Black Diamond	RT10435T





## SAILCLOTH REPLACEMENT TOPS

RT Off-Road's upgraded Sailcloth Replacement Soft Tops are a direct fit replacement for the factory cloth and windows. The upgraded sailcloth material reduces buffering and noises typical with soft top vehicles. These replacement soft tops are only available with tinted windows. Factory hardware must be reused.

Model	Year	Color	Part #
TJ	97/06	Black Diamond	RTS20035T
TJ	97/06	Spice	RTS20037T

## BOWLESS SOFT TOPS

RT Off-Road's Bowless Soft Top installs directly over the factory roll bar. It requires no additional supports and still maintains a snug fit. This design allows for larger side windows to improve visibility. When the side and rear windows are removed the top converts into an open air safari top. Each top includes tinted windows and storage pockets.

Model	Year	Color	Part #
JK 2DR	07/15	Black Diamond	BRT20035T
JK 4DR	07/15	Black Diamond	BRT20135T
TJ	97/06	Black Diamond	BRT10035
TJ	97/06	Spice Diamond	BRT10037
YJ	92/95	Black Diamond	BRT10135T

Note: Requires windshield channel, factory soft door surrounds and tail gate bar which are standard equipment on factory soft top applications. If the soft top is replacing a hard top application, additional parts are required and can be purchased separately.



BRT10135T



BRT10037



BRT10035



BRT20135T

## COVER ALL KITS

RT Off-Road's Cover All Kits are a unique way to outfit your vehicle with a weather resistant top system. While not completely weather tight, these Cover All Kits provide protection for vehicles without any top. Each Kit includes a beach topper, a wind breaker, and a tonneau cover. Tire cover and roll bar cover are not included.

Model	Year	Color	Part #
TJ	97/06	Black Diamond	CA10335
TJ	97/06	Spice	CA10337
YJ	87/91	Black Denim	CA10115
YJ	92/95	Black Denim	CA10215



## BEACH TOPPERS

Enjoy the open air feel while staying protected from direct sunlight and an unexpected rain. Windshield channels are sold separately and may be required.

Model	Year	Color	Part #
TJ	97/06	Black Diamond	BT40035 *
TJ	97/06	Black	BT40015 *
TJ	97/06	Spice	BT40037 *
YJ	87/91	Black	BT20001
YJ	87/91	Gray	BT20009
YJ	87/91	Black Denim	BT20015
YJ	92/95	Gray	BT30009
YJ	92/95	Black	BT30015
YJ	92/95	Spice	BT30037
CJ-5, M38A1	52/75	Black	BT10001
CJ-5	76/83	Black	BT10101
CJ-7	76/86	Black	BT10201

\* Also Fits Unlimited Models



## COMBO BEACH TOPPERS

RT Off-Road's Combo Beach Toppers allow occupants to enjoy the open air feel while staying protected from direct sunlight and an unexpected rain shower. Each kit is designed to be a versatile system, allowing to partial or full interior coverage. Windshield channels are sold separately and may be required.

Model	Year	Color	Part #
JK 2DR	07/15	Black Mesh	CB30011
JK 2DR	07/15	Black Diamond	CB30035
JK 2DR	07/15	Khaki Diamond	CB30036
JK 4DR	07/15	Black Mesh	CB30111
JK 4DR	07/15	Black Diamond	CB30135
JK 4DR	07/15	Khaki Diamond	CB30136
TJ	97/06	Black Denim	CB20015
TJ	97/06	Spice	CB20037
TJ	97/06	Black Mesh	CB20011
YJ	92/95	Black Denim	CB10015
YJ	92/95	Spice	CB10037
YJ	92/95	Black Mesh	CB10011



## WINDBREAKERS

RT Off Road's Windbreakers deflect the air behind the driver and passenger seats, creating an easier environment for conversation and listening to music. They mount behind the front seats to the factory roll bar and extend to the floor, reducing wind, moisture, and dust from entering the passenger compartment.

Model	Year	Color	Part #
JK	07/15	Black Denim	WB20035 *
TJ, YJ, CJ	76/06	Black Diamond	WB10035 *
TJ, YJ, CJ	76/06	Spice	WB10037 *
TJ, YJ, CJ	76/06	Black Denim	WB10015 *

\* Fits Unlimited Models



## TAILGATE BAR & TONNEAU COVER KIT

Replace your broken or missing tailgate bar and add a cargo cover for when the top is off the Jeep®. This is a dual function product that can either be used with a soft top or by itself as a tonneau/cargo cover. The bar assembly slides onto a channel for both your top and the cargo cover. The channel allows you to quickly change from a top to the cargo cover. The cargo cover keeps your valuables that you store behind your seat out of sight. The tailgate bar assembly installs in minutes into the factory location.

- Tailgate bar and retainers work with factory and most aftermarket tops.
- Black denim cargo cover encloses space between rear seat and tailgate.
- Includes instructions.
- Includes tailgate bar, retainer mounts, cargo cover, and all necessary hardware.
- Cargo cover can be removed and tailgate bar can be used with standard soft top.

Model	Year	Color	Part #
TJ	97/06	Black Denim	TN27015
YJ	87/95	Black Denim	TN27015





## TONNEAU COVERS

Keep gear clean, dry, and away from prying eyes with RT Off-Road's Tonneau Cover. Installs into factory belt rails and extends from the tailgate to the back of the front seats.

Model	Year	Color	Part #
TJ	97/06	Black Diamond	TN10135
TJ	97/06	Black Denim	TN10115
TJ	97/06	Spice	TN10137
YJ	87/91	Black Denim	TN10215
YJ	92/95	Black Denim	TN10015
YJ	92/95	Spice	TN10037



## FULL COVERS

RT Off-Road's Water Resistant Covers are designed to protect the vehicle from sun, dirt, dust, moisture, and pollution. The cover accomplishes this while also being a breathable enough to reduce moisture and temperature buildup. Includes cover, lock, cable, and storage bag.

Model	Year	Color	Part #
JK 2DR	07/15	Gray	FC10209
JK 4DR	07/15	Gray	FC10309
TJ Unlimited	04/06	Gray	FC10109
TJ, YJ, CJ-7	76/06	Gray	FC10009 *

\* Will NOT fit on Unlimited Models

## CAB ONLY COVERS

RT Off-Road's Cab Covers were designed for a tight fit that will last for years. The elastic bottom and straps will keep the cover tight to the body. The compact design provides easy storage when not being used.

Fits over factory roll bar. Waterproof.

Model	Year	Color	Part #
TJ, YJ	92/06	Gray	CC10209 *
YJ	87/91	Gray	CC10109
CJ-7	76/86	Gray	CC10009

Fits over factory soft or hard top. Non-water-resistant.

Model	Year	Color	Part #
TJ, YJ	92/06	Gray	CC10309 *
JK 2DR	07/15	Gray	CC10509
JK 4DR	07/15	Gray	CC10609

Waterproof with bottom door flaps. Compact design for ease of storage. Secures to body with elastic bottoms and straps.

Model	Year	Color	Part #
JK 2DR	07/15	Gray	CC10709
JK 4DR	07/15	Gray	CC10809

\* Will NOT work on Unlimited Models



CC10009



CC10709



CC10509



CC10609



## REPLACEMENT DOOR SKINS



Replace worn or damaged factory upper soft door skins with a set from RT Off-Road. Installs directly over factory door frame. Replacement upper door frames available separately. Sold in pairs.

Model	Year	Color	Part #
TJ	97/06	Black Denim	DS10115
TJ	97/06	Black Diamond	DS10135
TJ	97/06	Spice	DS10137
YJ	87/95	Black Denim	DS10015
YJ	87/95	Spice	DS10037

## REPLACEMENT UPPER DOOR FRAMES

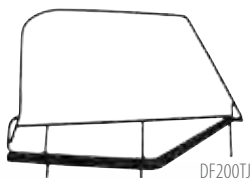

DF200TJ

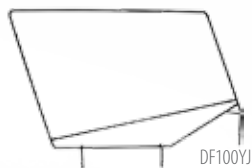

DF100YJ

Replace damaged or missing upper door frames with RT Off-Road's replacement door frame sets. Replacement upper door frames fit all factory half doors and work with our replacement upper door skins. Door frames are only available in pairs.

Model	Year	Color	Part #
TJ	97/06	Black	DF200TJ
YJ	87/95	Black	DF100YJ



## DOOR SURROUND KITS

RT Off-Road's Door Surround Kit is a direct fit replacement for the factory door surround. RT Off-Road's door surrounds are able to fit both factory soft tops, replacement tops, and bowless soft tops. Includes all hardware needed for installation and instructions.

Model	Year	Color	Part #
JK 2DR	07/15	Black	RT25001
JK 4DR	07/15	Black	RT25002



## DOOR PIN INSERTS

Direct replacement for OEM half steel door inserts. These inserts secure the upper window frame to the door. Three are required for each door.



### Single

Model	Year	Color	Replaces Part #
TJ, YJ	87/06	Charcoal (Lt. Gray)	5FB63JS1
TJ, YJ	87/06	Cinder (Dk. Gray)	5FB63RXA
TJ, YJ	87/06	Spice	5FB63RTB

### Set of Three

Model	Year	Color	Replaces Part #
TJ, YJ	87/06	Charcoal (Lt. Gray)	5FB63JS1K
TJ, YJ	87/06	Cinder (Dk. Gray)	5FB63RXAK
TJ, YJ	87/06	Spice	5FB63RTBK

## FREEDOM TOP PANEL STORAGE BAG

The Freedom Top Panel Storage Bag is a dual compartment storage system. The outside is constructed out of a durable canvas material while the inside is lined with a soft cloth to protect the panels. Designed to fit behind the rear seat.



Model	Year	Color	Part #
JK	07/15	Black	SB40001

## WINDOW STORAGE BAG

Finally a safe and convenient way to store a set of windows and upper doors. One of the most difficult things about taking the top off a Jeep is finding a place to safely store the windows and upper doors. We have solved this problem with our canvas storage bag. Now your windows and doors can be stowed safely and conveniently behind the rear seat. The internal felt separators will ensure their safety while removed from the vehicle. Storage bag works on most Jeep vehicles with a soft top and upper soft doors.

- Heavy duty black canvas material
- Protects windows and upper doors from scratches
- Stores easily behind rear seat
- Felt liners keep windows from rubbing against one another.
- Convenient handle for transporting windows and upper doors

Model	Year	Color	Part #
TJ, YJ, CJ	76/06	Black	SB40002



## TIRE COVERS

Protect your spare tire from the elements with a RT Off-Road tire cover. The elastic slip on design allows for easy installation while still maintaining a tight fit. The canvas material protects expensive tire and wheel combinations from corrosive road chemicals, salts, and UV light.

Tire Size	Color	Part #
27" to 29"	Black	TC272901
27" to 29"	Gray	TC272909
27" to 29"	Black Denim	TC272915
27" to 29"	Spice	TC272937
30" to 32"	Black	TC303201
30" to 32"	Gray	TC303209
30" to 32"	Black Denim	TC303215
30" to 32"	Spice	TC303237
33" to 35"	Spice	TC333537
33" to 35"	Black Diamond	TC333515



## SOFT TOP STORAGE SLEEVES

Protect your soft top with RT Off-Road's Soft Top Storage Sleeves. Installs quickly and easily on top with no special tools. Available in multiple colors for a direct match to soft top material.

Model	Year	Color	Part #
JK 2DR	07/15	Black Diamond	SB20035
JK 2DR	07/15	Khaki Diamond	SB20036
JK 4DR	07/15	Black Diamond	SB30035
JK 4DR	07/15	Khaki Diamond	SB30036
TJ	97/06	Gray	SB10009
TJ	97/06	Black Denim	SB10015
TJ	97/06	Spice	SB10037





## WINDSHIELD CHANNELS

RT Off-Road's Windshield Channel is designed for aftermarket beach toppers, combo toppers, and bowless replacement tops. Installs to factory windshield frame and includes all hardware needed for installation.

Model	Year	Comments	Part #
JK	07/15	No Drill	RT26067
TJ	97/02	Drill In	RT26065
TJ	97/06	No Drill	RT26066
YJ, CJ	76/95	Drill In	RT26064



## SOFT TOP DISCONNECTS

RT Off-Road's Soft Top Disconnect Kit is an upgraded aluminum disconnect kit for the TJ Wrangler. The factory plastic disconnects are known to crack, fracture, and eventually fail. These upgraded aluminum disconnects will install and function just as the factory disconnects.

Model	Year	Color	Part #
TJ	97/06	Black	RT26063
TJ	97/06	Aluminum	RT26062



RT26062

## SOFT TOP RETAINERS

A direct replacement for missing, damaged, or stolen tailgate retainers. Sold individually and are specific for driver or passenger side. Connects soft top to tailgate for weather tight seal.

Model	Year	Position	Replaces Part #
JK	07/14	Right	68041620AA
JK	07/14	Left	68041621AA



**SEAT COVERS SETS FOR YJ, TJ WRANGLERS™**

These easy to install seat covers are made from durable poly canvas.

The front seat sets include 2 front seat covers, 2 shoulder harness belt pads and a steering wheel cover. The seat covers have adjustable side lace-up draw cords that create a snug fit. Front and side mounted zippered mesh pockets add convenient storage space. Large rear pockets add additional rear access storage space. Included rear carabiner clip is handy for hanging and securing small items. The steering wheel cover installs in seconds without glue or tape. The rubberized interior of the steering wheel cover allows for exceptional grip.

The rear seat sets include one bench seat cover and two shoulder harness belt pads. There is a large storage pocket on the back side of the seat cover.

Both front and rear sets are available in 3 color combinations: Black/Gray, Black/Tan and Black/Red.



### Front Seat Cover Sets

Model	Year	Color	Part #
TJ	03/06	Black & Gray	SCP20021
TJ	03/06	Black & Tan	SCP20024
TJ	03/06	Black & Red	SCP20030
TJ, YJ	87/02	Black & Gray	SC10021
TJ, YJ	87/02	Black & Tan	SC10024
TJ, YJ	87/02	Black & Red	SC10030

### Rear Seat Cover Sets

Model	Year	Color	Part #
TJ	03/06	Black & Gray	SCP20221
TJ	03/06	Black & Tan	SCP20224
TJ	03/06	Black & Red	SCP20230
TJ, YJ	87/02	Black & Gray	SCP20121
TJ, YJ	87/02	Black & Tan	SCP20124
TJ, YJ	87/02	Black & Red	SCP20130



SC10021



SC10024



SC10030

## SEAT COVERS FOR JK WRANGLERS™

These durable polycanvas seat covers are custom made for a snug fit. The front seat covers have a built-in Side Air Bag pocket for added safety. There are zippered mesh pockets on the front and sides of the seat for convenient storage. Large rear pockets offer additional storage. Custom fit headrest covers are included. Heavy duty straps and clips make installation easy. Available in Black/Gray only.

### Front Seat Covers (2)

Model	Year	Color	Part #
JK	07/10	Black & Gray	SC30021

### Rear Seat Covers (2)

Model	Year	Color	Part #
JK - 2DR	07/11	Black & Gray	SC30121
JK - 4DR	07/11	Black & Gray	SC30221



## HEAVY DUTY BUMPERS

### TJ and YJ Wrangler Bumpers

RT Off-Road's Heavy duty front and rear bumpers are a heavy duty plate steel constructed upgrade over factory bumpers. The 3/16" thick plate steel construction is protected with a durable gloss black powder coat. Bumpers include D-Rings for recover use and mounting holes that are in the same location as the factory. Includes all hardware needed for installation and does not require any drilling or modification.



RT20001



RT20003



RT20005

Model	Year	Position	Part #
TJ	97/06	Front	RT20001
TJ	97/06	Rear	RT20003
YJ	87/95	Front	RT20001
YJ	87/95	Rear	RT20003

This RT Off-Road rear bumper and tire carrier was engineered for severe use on a trail rig as well as standard operation on a daily driver. The bumper's angled profile increases your departure angle without sacrificing overall strength. With this bumper we also recommend also purchasing RT Off-Road's RT33009 2" receiver and d-ring.

- Durable Textured Black Powder Coat Finish
- 3/16" Plate Steel Construction
- 2" Receiver
- Carrier will hold oversized tire and wheel combinations
- Carrier accepts 5 on 4.5" bolt pattern wheels

Model	Year	Position	Part #
TJ	97/06	Rear	RT20005
YJ	87/95	Rear	RT20005

### JK Wrangler Bumpers

RT Off-Road's Heavy duty Front Bumper is a steel constructed upgrade over the factory bumper. The plate steel and tubular steel construction is protected with a durable textured black powder coat. Bumper includes winch mount, winch fairlead mounting holes, and additional holes for mounting lights. Includes all hardware needed for installation, installs into factory locations, and does not require any drilling or modification.



Model	Year	Position	Part #
JK	07/15	Front	RT20013

RT Off-Road's Rear Bumper is a heavy duty steel constructed upgrade over the factory bumper. The 3/16" plate steel construction is protected with a durable textured black powder coat finish. This rear bumper includes mounting points for d-rings and a large recess for oversized tire clearance. Includes all hardware needed for installation, installs into factory locations, and does not require any drilling or modification.



Model	Year	Position	Part #
JK	07/15	Rear	RT20014



RT20013

## ROCKER PANEL GUARDS

RT Off-Road's Heavy Duty Rocker Panel Guard Set is a required upgrade for serious rock crawling off-road enthusiasts. The heavy duty plate steel construction protects the vehicles rocker panels from rocks, trees, and all other obstacles one may encounter on the trail. They are protected with a gloss black powder coated finish that will provide years of protection. Kit includes both driver and passenger side rocker panel guards, all hardware needed to install, and installation instructions.

- 2003-2006 Models require modification to guard or relocation of seat belt mounting bolt
- Drilling required

Model	Year	Part #
TJ	97/06	RT26046



## SKID PLATE

Replace the factory plastic brush guard with a heavy duty plate steel skid plate. Keep the electronic sway bar disconnect and steering components safe from rocks, brush, and any potential contact. Direct bolt in design using existing holes. No drilling required. Installs with basic hand tools.

- Black Powder Coat Finish
- 3/16" Plate Steel Construction
- Drilling not required
- Includes all hardware needed for installation



Model	Year	Part #
JK	07/15	RT20017





## TUBE BUMPERS

RT Off-Road's Double Tube Bumper design is sure to freshen up the look of your vehicle. All tube bumpers are constructed out of 3" diameter tubing and has a durable powder coated finish. These tube bumpers are designed to install in the factory holes and require no additional drilling or modifications.

### Front Bumper

Model	Year	Part #
JK	07/15	RT20018
TJ	97/06	RT20006
TJ	97/06	RT20008
YJ	87/95	RT20006
YJ	87/95	RT20008

### Rear Bumper

Model	Year	Part #
JK	07/15	RT20019
TJ	97/06	RT20007
TJ	97/06	RT20008
YJ	87/95	RT20007
YJ	87/95	RT20008



## ROCK CRAWLER BUMPERS

Introducing RT Off-Road's Front Rock Crawler Bumper for YJ, TJ, and JK Wrangler. This heavy duty winch-ready bumper will eliminate any possibility of damage to the grille and fender area of the Jeep as well as function as a recovery point. Installation is as simple as removing the factory bumper cover and bumper before installing the Rock Crawler Bumper. Each kit includes a bumper and all hardware needed to install it.



### Front Bumper

Model	Year	Color	Part #
TJ	97/06	Black	RT20009
YJ	87/95	Black	RT20009

Durable, textured black powder coat finish. Accepts most winches up to 9,000 lbs. 2 D-Ring Mounts. Full fender to fender protection. Easy No-Drill Installation.

Model	Year	Color	Part #
JK	07/14	Black Textured	RT20015

### Rear Bumper

Model	Year	Comment	Part #
TJ	97/06	With Tire Carrier	RT20004
TJ	97/06	Without Tire Carrier	RT20010
YJ	87/95	With Tire Carrier	RT20004
YJ	87/95	Without Tire Carrier	RT20010



RT20004



## TUBE SIDE STEPS

RT Off-Road's Side Steps will make entering and exiting the vehicle much easier as well as improving side protection from obstacles. Installation is a breeze, using the factory body mounting bolts to mount the steps to the vehicle. Each kit includes left and right steps, mounting brackets, hardware, and installation instructions.

- Durable, black powder coat finish
- No-Slip flats for entering and exiting the vehicle
- 3" Diameter Tubes
- Works with vehicles with (or without) a body lift
- Easy No-Drill Installation

Model	Year	Comments	Part #
JK	07/14	2 Door	RT26059
JK	07/14	4 Door	RT26058
JK	07/13	4 Door; Black Textured	RT26060
JK	07/13	2 Door; Black Textured	RT26061
TJ	97/06	Black	RT26015 *
TJ	97/06	Black Textured	RT26016 *
YJ	87/95	Black	RT26015
YJ	87/95	Black Textured	RT26016

\* Will NOT work on Unlimited Models





## ADJUSTABLE CONTROL ARM KITS

Improve your Jeep's performance with a set of RT Offroad's Heavy Duty Control Arm Sets. The flex ends are utilized to improve the articulation and relieve suspension binding while maintaining a smooth, comfortable ride. The adjustability of these control arms will allow the caster and pinion to be tuned to factory specifications. Each kit includes a pair of fully assembled, zinc plated control arms with greasable bolts for both ends of the control arms.

- Zinc Plated
- Adjustable
- Fits Jeeps with 0-6" of lift
- Includes Greasable Hardware
- Sold in Pairs



Model	Year	Location	Position	Part #
TJ	97/06	Front or Rear	Lower	RT21013
TJ	97/06	Rear Only	Upper	RT21026
XJ, MJ	84/01	Front Only	Lower	RT21013
ZJ	93/98	Front Only	Lower	RT21013

**Front Upper Control Arm Set**

Model	Year	Part #
TJ	97/06	RT21014
XJ	84/01	RT21014
MJ	86/92	RT21014
ZJ	93/98	RT21014

**RT21013 Rebuild Kit**

Small parts kit for RT21013 Adjustable Lower Control Arm Kit.

Model	Year	Part #
TJ	97/06	RT21016
XJ	84/01	RT21016
ZJ	93/98	RT21016



## SPACER LIFT KITS



RT21028



RT21035



RT21037

Improve the look and off-road performance of your vehicle with RT Off-Road's Lift Kit. These kits lift the vehicle 1 3/4", improving ground clearance allowing the use of oversized tires.

- Fits all available models
- 1 3/4" Poly Spacer Kit
- Black Polyurethane construction
- Shocks are not included unless noted

Model	Year	Comments	Part #
JK	07/15	1 3/4" Lift	RT21035
TJ	97/06	1 3/4" Lift	RT21028
TJ	97/06	1 3/4" Lift	RT21029 *
XJ	84/01	1 3/4" Lift	RT21046
KJ	02/07	2" Lift	RT21050
WJ, WG	99/04	1 3/4" Lift	RT21037

\* Master Kit, Includes HD Shocks



RT21046



RT21050



RT21029



## WK and XK

This kit improves ground clearance by lifting the front of the vehicle 2" and the rear 1-3/4" to remove the rake that the vehicle has from the factory. Lifting the vehicle increases ground clearance and allows the use of oversized tires. Each spacer is constructed of MIG welded steel and finished in a rich black powder coat. All necessary hardware is included.

- Lifts & Levels for Improved Stance
- Allows for the use of Oversized Tires
- Includes Front & Rear Spacers and Hardware
- Rich Black Powder Coat Finish

Model	Year	Comments	Part #
XK	06/10	2" Lift	RT21038
WK	05/10	2" Lift	RT21038



## HEAVY DUTY GREASABLE SHACKLE KITS

Improve the performance, durability, and look of your suspension with RT Off-Road's Heavy Duty Shackle Kit. The shackle plates and reinforcement sleeves are finished in a rich black powder coat. Installation is as simple as removing the factory shackle assemblies and installing the supplied shackles.

- Effectively lifts vehicle 3/4"
- Heavy duty plate steel construction
- Includes installation instructions

Model	Year	Location	Description	Part #
YJ	87/95	F or R	For 2 Springs	RT21049
YJ	87/95	F and R	For 4 Springs	RT21023
CJ	53/75	F or R	For 2 Springs	RT21021

RT21021



RT21049



These Heavy Duty Greasable Shackles are made from 1/4" plate and feature a greasable bushing for a noise-free ride.

Model	Year	Description	Part #
XJ	84/01	1.5" Lift	RT21045
MJ	86/92	0.75" Lift	RT21045





## PERFORMANCE SWAY BAR LINKS

RT Off-Road's upgraded Sway Bar Links are an affordable upgrade that increases performance and handling. Not only will your vehicle perform better with our upgraded polyurethane bushing and boots, but the product will last longer than the factory rubber pieces it replaces. All sway bar links install in place of the factory link.

- Black powder coated body with blue polyurethane boots and bushings
- Polyurethane bushings Provide long lasting performance and handling
- Installs using factory hardware

### Single Link

Image	Model	Year	Location	Part #
A	TJ	97/06	Front	RT21031
B	TJ	97/06	Rear	RT21032
C	YJ	87/95	Front	RT21024
D	XJ, MJ	91/01	Front	RT21019
E	XJ	84/01	Rear	RT21047
D	ZJ	93/95	Front	RT21019
F	ZJ	96/98	Front	RT21041
G	WJ, WG	99/04	Front	RT21039
H	WJ	99/04	Rear	RT21040
I	WK	05/07	Rear	RT21042
J	WK	05/10	Rear	RT21043
I	XK	06/07	Rear	RT21042
J	XK	06/10	Rear	RT21043

### Set of 2 Links

Model	Year	Location	Part #
TJ	97/06	Front	RT21033
TJ	97/06	Rear	RT21034
YJ	87/95	Front	RT21025
XJ, MJ	91/01	Front	RT21020
ZJ	93/95	Front	RT21020
ZJ	96/98	Front	RT21044



## DROP PITMAN ARMS

Improve steering performance with RT Off-Road's Drop Pitman Arm. Lifting your Jeep without addressing the steering angles often times results in bump steer and decreased turning radius. Installation of this drop pitman arm will reduce the operating angle of the drag link, resulting in improved steering feel and less wear on steering parts. Each arm is designed to bolt in place of the factory piece with no interference issues.



RT21012



RT21001



RT21036

- Improve Steering Feel
- Reduce Drag Link Angle
- Improve Turning Radius
- Designed to bolt in place of OE arm

Model	Year	Comments	Part #
JK	07/15	LHD, with 6+” Lift	RT21036
TJ	97/06	LHD, with 8+” Lift	RT21001
YJ	87/95	LHD, with 4+” Lift	RT21012
XJ	84/01	LHD, with 4+” Lift	RT21001
ZJ	93/98	LHD, with 4+” Lift	RT21001

## PERFORMANCE SHOCK ABSORBERS

Model	Year	Comments	Part #
TJ	97/06	Rear; For 3” Lift	RT21030
TJ	97/06	Front; For 3” Lift	RT21018
XJ, MJ	84/01	Front; For 3” Lift	RT21018



RT21030



RT21018

## BUMP STOP SET

RT Off-Road's Extended Bump Stops prevent expensive body damage to lifted Jeep vehicles. They measure 5" long and install in place of the factory foam bump stops. The polyurethane construction results in a longer product life and improved suspension control. They can be shortened to achieve the perfect amount of suspension articulation while still preventing the tires from contacting the body.

- Polyurethane Construction
- 5" Long
- Simple Installation
- Designed for Vehicles w/ Suspension Lift
- Limits Suspension Travel to Help Clear Oversized Off-Road Tires



Model	Year	Comments	Part #
TJ	97/06	Front	RT21027
ZJ	93/98	Front	RT21027

## HEAVY DUTY ADJUSTABLE FRONT TRACK BAR

RT Off-Road's adjustable track bar is a heavy-duty, adjustable upgrade over your factory bar. The adjustable assembly allows you to dial in your suspension's alignment to guarantee that the axle is centered under the front of the vehicle. The 1.25" DOM Tubing has a heavy wall thickness that will withstand years of abuse on the trails.

- For vehicles with 0-5" of lift
- 1.25" DOM tubing
- Requires no drop brackets, drilling, or modification. Installs in factory location.
- Black powder coated finish.
- Will not work on Right Hand Drive vehicles

Model	Year	Comment	Part #
TJ	97/06	With LHD, with 0-5" Lift	RT21017
XJ	84/01	With LHD, with 0-5" Lift	RT21017
ZJ, ZG	93/98	With LHD, with 0-5" Lift	RT21017
MJ	86/93	With LHD, with 0-5" Lift	RT21017



## HEAVY DUTY STEERING SHAFTS

RT Off-Road's Steering upgrades are an affordable way to regain and improve the vehicle's on road performance. All of our upgraded steering components are engineered to improve upon the factory design to increase responsiveness and handling. We then go a step further and improve the durability and rigidity by increasing material thickness and component construction methods. Even with these upgrades your RT Off-Road product will still install into the factory locations with simple hand tools.

Model	Year	Comment	Part #
CJ	72/86	Manual Steering	RT21010
CJ	76/86	Power Steering	RT21011



RT21010



## EXTREME HEAVY DUTY STEERING BOX BRACKET

- For models with power steering
- Durable black powder coat finish
- Heavy duty plate steel construction
- Includes all hardware needed for installation
- Installation instructions included



Model	Year	Comments	Part #
CJ	76/86	With Power Steering	RT21009





## HEAVY DUTY STEERING KITS

- Heavy Duty Solid Steel Construction
- No modifications needed to factory mounting components
- Left hand drive models only
- Includes all hardware needed for installation
- Steering Stabilizer included

### Steering Stabilizer Included

Model	Year	Drive Side	Part #
TJ	97/06	LHD	RT21005
TJ	97/04	RHD	RT21007
XJ, MJ	91/01	LHD	RT21005
XJ	94/01	RHD	RT21007
ZJ w/4.0L	93/98	LHD	RT21005
ZG w/4.0L	94/98	RHD (Europe)	RT21007

### Steering Stabilizer Not Included

Model	Year	Drive Side	Part #
TJ	97/06	LHD	RT21004
TJ	97/04	RHD	RT21006
XJ, MJ	91/01	LHD	RT21004
XJ	91/01	RHD	RT21006
ZJ w/4.0L	93/98	LHD	RT21004
ZG w/4.0L	94/98	RHD (Europe)	RT21006



## HEAVY DUTY BALL JOINT SETS

The “Heavy Duty” description is more than accurate with these ball joints. The newly designed joint is leaps ahead of the OE plastic bushings plagued with premature failure. These HD Ball Joints were manufactured with a sintered metallic bushings. This new bushing is highly resistant to wear and damage. The assembly is greaseable to extend the life of the already durable bushings specifically engineered for vehicles with larger tires, lift kits, and heavier accessories. They install without any fabrication or modification to the factory mounts using tools that can be purchased or rented at a local parts store. The HD Ball Joints are also backed with an industry leading 12 month warranty. Each set includes one upper and one lower Ball Joint with all required hardware needed for installation.

Set includes 1 Upper and 1 Lower Ball Joint with Hardware.

Model	Year	Part #
TJ	97/06	RT21003
YJ	87/95	RT21003
XJ	84/01	RT21003
MJ	86/92	RT21003
ZJ	93/98	RT21003



- Heavy Duty Replacement of Factory Ball Joints
- Heavy-Duty Sintered Metallic Bushings
- Greaseable AssemblyHD Ball Joint Set
- Includes All Hardware Needed for Installation
- Sold In Sets (Must Order two sets to complete one front axle)

Model	Year	Part #
JK	07/15	RT21002
WJ	99/04	RT21002



## HEAVY DUTY CONTROL BRACKET ARM SET

RT Off-Road's Lower Control Arm Bracket Set is a heavy-duty replacement for the failure prone factory mounts. The 3/16" plated steel construction will ensure long lasting performance even with the most rigorous off-road use. The slotted cam bolt design will allow you to dial in the front caster and improve overall ride quality. Cam bolt kits are available separately, replaces part #6504238K. Installation will require cutting, grinding, and welding.

- Brackets are shipped in bare steel
- Welding Required
- Sold in pairs
- Replacement Cam bolt available separately

Model	Year	Part #
TJ	97/06	RT21015
XJ	84/01	RT21015
MJ	86/92	RT21015
ZJ	93/98	RT21015



## SECURE DISCONNECT LOCK KITS

A major problem in late 80's and early 90's Jeep Vehicles were the vacuum disconnect front axles. The RT Off-Road Secure Disconnect Lock System removes and replaces that failure prone vacuum disconnect. The factory disconnect assembly is replaced with a reliable cable actuated system. The stainless steel cable is zinc coated to protect the already durable finish. Our aluminum housing replaces the factory vacuum assembly and installs directly in place with a new gasket. Our wiring kit will ensure the factory 4WD light continues to operate as it did originally. Finally, our dash bracket and hardware kit will make installation a snap.

With Disconnect Front Axle; with 0–3" Lift

Model	Year	Part #
YJ	87/95	RT23002
XJ	84/93	RT23002
MJ	86/92	RT23002

With Disconnect Front Axle; with 3" or Higher Lift

Model	Year	Part #
YJ	87/95	RT23003
XJ	84/93	RT23003
MJ	86/92	RT23003

### Shift Fork Kit

With Dana 30 Front Axle with disconnect; Includes HD Fork, Gasket, Clips, Snap Rings, and Hardware.

Model	Year	Part #
YJ	87/95	RT23004
XJ	84/93	RT23004
MJ	84/93	RT23004



## HD DIFFERENTIAL COVERS

Protect high-dollar differentials with a Heavy Duty Differential Cover from RT Off-Road. These covers are constructed of 3/8" high grade forged steel with a raised fill plug for extra oil capacity. They feature strengthening ribs to ensure a broken or peeled differential cover doesn't cut the day short. The mating surface is machined flat to ensure a leak-free fitment. All covers are finished in a red powder coat and include flanged hex bolts as well as RTV.

- Constructed of 3/8" Forged Steel
- Mating surface machined flat to prevent leaks
- Raised fill plug for increased oil capacity
- Powder Coated Red
- Includes hardware and RTV



Description	Model	Year	Position	Part #
D30 HD Differential Cover	Universal	47/15	Front or Rear	RT20024
D35 HD Differential Cover	Universal	84/07	Rear	RT20025
D44 HD Differential Cover	Universal	47/15	Front or Rear	RT20026
8.25" HD Differential Cover	Universal	91/12	Rear	RT20027



RT20024



RT20025



RT20026



RT20027



## PERFORMANCE AXLE SETS

RT Off-Road continues our tradition of high-quality, heavy-duty, products with Performance Axle Kits. These axles are a direct replacement for the factory shaft but are upgraded to a 4340 alloy steel. This alloy is heat treated to improve both tensile and torsional strength by 30%. The shaft splines are rolled, not cut, into the shaft to further increase overall component strength. Sold in pairs and includes hardware.

### DANA 35 PERFORMANCE AXLE KIT

For Vehicles with Rear Drum Brakes

Model	Year	Part #
TJ	97/02	RT23001
YJ	93/95	RT23001
XJ	92/01	RT23001
ZJ	93/96	RT23001
MJ	1992	RT23001





**DANA 35 PERFORMANCE AXLE KIT**

For Vehicles with Rear Disc Brakes

Model	Year	Part #
ZJ	94/98	RT23005

**DANA 44 PERFORMANCE AXLE KIT**

Backing plates not included

Model	Year	Part #
ZJ	94/98	RT23006



RT23005



## SLIP YOKE ELIMINATOR KIT

Eliminate drive line vibrations and increase the strength of your NP231 with RT Off-Road's Slip Yoke Eliminator Kit. Each kit includes a replacement output housing, heavy duty Main Shaft, rear output Yoke designed for a double-cardan drive shaft, and all necessary hardware. The Installation can be performed with the transfer case in or out of the vehicle with basic hand tools. Engineered to function with the factory Speedometer sensor/cable and Vacuum Shift Sensor.

- Fits all Jeep NP231 transfer cases
- 1-3/8" 32-Spline Main Shaft and Yoke
- Converts factory rear slip yoke to a CV style output
- Includes installation instructions

Model	Year	Part #
TJ	97/06	RT24005
YJ	87/93	RT24005
XJ	87/01	RT24005
MJ	87/92	RT24005



## HEAVY DUTY DRIVE SHAFT

- For Use With RT24005 Slip Yoke Eliminator Kit
- Functional Lengths: Collapsed 16", Extended 18.25," 2-6" Lifts
- Heavy Duty Rear Propeller Shaft
- Include 3 Grease Fittings and Instructions

Model	Year	Part #
TJ	97/06	RT24002
YJ	87/93	RT24002
YJ	94/95	RT24002 *

\* With 1310 (3.219" Width) Series U-Joints. If 94/95 YJ has 1330 Series U-Joint, also purchase Part # D35YOKEUBK.



## SLIP YOKE ELIMINATOR & HEAVY DUTY DRIVE SHAFT KIT

This kit contains everything you need to convert the rear output of the NP231 transfer case to a fixed-style yoke. Included in this kit is a heavy duty 32 spline main shaft, a short output housing, a CV-style Yoke, and all the necessary hardware. When paired with the provided Propeller Shaft, these kits will result in an extremely strong, vibration free driveline that will provide you with years of worry free driving.

Model	Year	Part #
TJ	97/06	RT24004
YJ	87/93	RT24004
YJ	94/95	RT24004 *

\*With 1310 (3.219" Width) Series U-Joints. If 94/95 YJ has 1330 Series U-Joint, also purchase Part # D35YOKEUBK.





## STAINLESS STEEL BRAKE LINE KITS

RT Off-Road Stainless Steel Brake Lines are designed for modified vehicles requiring additional length and performance. The additional length and stainless construction provides long lasting performance on modified vehicles. All brake lines are D.O.T. approved, 50 state legal. Each kit includes stainless lines to replace the factory soft lines, mounting brackets, junctions blocks (if required), copper washers, and mounting hardware.

- Braided Stainless Steel Construction
- Fits Models with 0-4" of lift
- D.O.T. Approved

Model	Year	Comment	Part #
JK	07/10	Up to 6" Lift	RT31029
TJ	97/02	Up to 6" Lift	RT31015
YJ	87/95	Up to 6" Lift	RT31015
XJ	84/01	Up to 6" Lift	RT31015
CJ	82/86	Up to 4" Lift	RT31016

DOT SAE J1401 01/08 HL

DOT SAE J1401 01/08



# RT31016



# RT31015



# RT31029



## HIGH PERFORMANCE BRAKE ROTORS

High Performance Brake Rotors from RT Off-Road are designed for the most extreme abuse. These Brake Rotors were tested on: the steep descents in Moab, Utah; stop and go traffic in Boston, Massachusetts; and the long range treks in-between. Each brake rotor is machine slotted and cross drilled to provide maximum cooling. This drastic cooling helps eliminate brake fade and potential warping. The design rapidly expels friction gases, debris, and water from the rotor and pad surface. You can expect greater braking response, increased performance, longer life, and a sporty new look.

Model	Year	Comments	Location	Part #
JK	07/15	With 11.89" Diameter Rotor	Front	RT31025
JK	07/15		Rear	RT31026
TJ	99/06	With Full Cast Type Rotor	Front	RT31001
TJ	97/99	With 2 Piece Composite Rotor	Front	RT31002
TJ	03/06	With Rear Disc Brakes	Rear	RT31005
YJ	90/95		Front	RT31002
KJ	03/07		Rear	RT31005
WJ, WG	99/04	With Akebono or Teves caliper	Front	RT31032
WJ, WG	99/04		Rear	RT31031
WK, WH	05/10	Without SRT 8 Package	Front	RT31003
WK, WH	05/10	Without SRT 8 Package	Rear	RT31004
XJ	99/01	With Full Cast Type Rotor	Front	RT31001
XJ 2WD	92½/99	With 2 Piece Composite Rotor	Front	RT31002
XJ, MJ 4WD	90/99	With 2 Piece Composite Rotor	Front	RT31002
XK, XH	06/10		Front	RT31003
XK, XH	06/10		Rear	RT31004
ZJ, ZG	93/98		Front	RT31002
ZJ, ZG	94/98		Rear	RT31030





RT31025



RT31026



RT31001



RT31005



## COMPLETE BRAKE KITS WITH DRILLED & SLOTTED ROTORS

High Performance Brake Rotors from RT Off-Road are designed for the most extreme abuse. These brake rotors were tested on: the steep descents in Moab, Utah; stop and go traffic in Boston, Massachusetts; and the long range treks in between. Each brake rotor is machine slotted and cross drilled to provide maximum cooling. This drastic cooling helps eliminate brake fade and potential warping. The design rapidly expels friction gases, debris, and water from the rotor and pad surface. You can expect greater braking response, increased performance, longer life, and a sporty new look.

Model	Year	Comments	Location	Part #
JK	07/15	With 11.89" Diameter Rotor	Front	RT31027
JK	07/15		Rear	RT31028
TJ	99/06	With Full Cast Type Rotor	Front	RT31012
TJ	97/99	With 2 Piece Composite Rotor	Front	RT31013
TJ	03/06	With Rear Disc Brakes	Rear	RT31014
YJ	90/95	With 2 Piece Composite Rotor	Front	RT31013
KJ	03/07		Rear	RT31014
WJ, WG	99/04	With Teves caliper	Front	RT31035
WJ, WG	99/04	With Akebono caliper	Front	RT31036
WJ, WG	99/04		Rear	RT31034
WK, WH	05/10	Without SRT8 Package	Front	RT31008
WK, WH	05/10	Without SRT8 Package	Rear	RT31009
XJ	99/01	With Full Cast Type Rotor	Front	RT31012
XJ 2WD	92½/99	With 2 Piece Composite Rotor	Front	RT31013
XJ 2WD	99	With 2 Piece Composite Rotor	Front	RT31013
XJ, MJ 4WD	90/99	With 2 Piece Composite Rotor	Front	RT31013
XK, XH	06/10		Front	RT31008
XK, XH	06/10		Rear	RT31009
ZJ, ZG	93/98		Front	RT31013
ZJ, ZG	94/98		Rear	RT31033



RT31027



RT31028



## DRUM TO DISC BRAKE CONVERSION KITS

The RT Off-Road disc brake conversion kits will convert factory Dana 35 or Chrysler 8.25" rear axles from drum to disc brake. This is a must for vehicles with oversized tires and increased accessory weight. These kits are designed for vehicles without ABS and include all hardware, emergency brake cables, and brake hoses needed for installation.

- Dana 35 for Chrysler 8.25" axles only
- Will not work on vehicles equipped with ABS
- Converts Rear Drum Brakes To Disc Brakes
- Incl: Rotors, Pads, Calipers, Backing Plates, Shoes, Brake Hoses, & Hardware

Model	Year	Part #
TJ	97/06	RT31006
TJ	97/06	RT31007 *
YJ	91/95	RT31007 *
XJ	91/01	RT31007 *
ZJ	93/98	RT31006
ZJ	93/98	RT31007 *

\* Emergency brake cables sold separately.



### Brake Cables for use with RT31007

RT Off-Road Disc Brake Conversion Cables are designed specifically for our disc brake conversion kits. These Cables are designed to bolt directly in place of the old factory Drum emergency Brake Cable. Their updated design will however operate the new disc brake conversion E-Brake mechanism. Cables are sold individually and may be position specific.

Model	Years	Length	Position	Part #
TJ	97/06	44"	Right	52008904
TJ	97/06	43.80"	Left	52008905
YJ	87/90	64.75"	Right	RT31019
YJ	87/90	32.75"	Left	RT31020
YJ	91/95	69.75"	Right	RT31021
YJ	91/95	37.5"	Left	RT31022
XJ	84/96	52"	L or R	RT31039
XJ	97/01	70.5"	Right	RT31040
XJ	97/01	34.25"	Left	RT31041
ZJ	93/98	44"	Right	52008904
ZJ	93/98	43.80"	Left	52008905



RT31019



RT31020



RT31021

RT31022



## HEAVY DUTY DUAL DIAPHRAGM BRAKE BOOSTER & HIGH PRESSURE MASTER CYLINDER KITS

Replace rusty, leaky, and faulty Brake Boosters & Master Cylinders with a HD kit from RT Off-Road. Two performance level kits were designed to specifically cater to the vehicles requirements. The larger bore Master Cylinders are designed for upgrades done to axles with larger brake calipers. The more moderate bore is designed for vehicles with factory brakes, disc brake upgrades, and vehicles that require more braking power. Each kit consists of a zinc-coated Brake Booster, Master Cylinder, bench bleeding kit, and installation instructions. Installation involves replacing the factory brake booster & master cylinder.

- Work on all available models
- Includes mounting bracket and adjustable push rod assembly
- Includes installation instructions

### Aftermarket Axles

Model	Years	MC Bore Size	Comment	Part #
TJ	97/06	1-1/8"	Without ABS	RT31024
YJ	87/90	1-1/8"	Without ABS	RT31017
YJ	91/95	1-1/8"	Without ABS	RT31010
XJ, MJ	84/01	1-1/8"	With or Without ABS	RT31037
CJ	76/86	1-1/8"		RT31010

### Stock Applications

Model	Years	MC Bore Size	Comment	Part #
TJ	97/06	1"	Without ABS	RT31023
YJ	87/90	1"	Without ABS	RT31017
YJ	91/95	1"	Without ABS	RT31011
XJ, MJ	84/01	1"	With or Without ABS	RT31038
CJ	76/86	1"		RT31011



## HALOGEN LAMP CONVERSION KITS

The RT Off-Road Lamp conversions are an upgrade for the conventional factory sealed beam headlamps. Included in the Headlight Conversion Kit are two halogen bulbs and two cast housings with clear glass lenses. RT Off-Road's Halogen Light Conversion Kit is DOT and SAE compliant.

- Pair of 7" Round Assemblies
- H4 55/60W Bulbs
- Cast Housing
- Clear Glass Lens
- Meets DOT/SAE



### Lamps

Model	Year	Comment	Part #
YJ, XJ, MJ, SJ	79/01	200MM Rectangular Assemblies	RT28005
CJ, TJ	69/06	7" Round Assemblies	RT28006



### Bulbs

Model	Year	Comment	Part #
YJ	87/95	H4-60W Super White;2 bulbs; Europe	RT28004
XJ	84/01	H4-60W Super White;2 bulbs; Europe	RT28004

Note: Standard Blue Halogen Bulbs also available.



## CLEAR PARKING LAMPS & SIDEMARKER LAMPS

The RT Off-Road Crystal Clear lighting packages are a D.O.T. legal way to give the vehicle an all new look. These crystal clear Lenses come complete with amber Bulbs. The bulbs and lenses included in our kit will install directly into the factory wiring harness and body. Installation requires no modifications to the body and can be completed with basic hand tools.

### Parking Lamps

Includes: 2 Parking Lamps and 2 Amber Bulbs

Image	Model	Year	Part #
A	JK	07/13	RT28029
B	TJ	97/06	RT28016
C	YJ	87/95	RT28012

Note: Modifications to Parking Lamp Wiring Required for 94/95 YJ



### Sidemarker Lamps

Includes: 2 Sidemarker Lamps and 2 Amber Bulbs

Image	Model	Year	Part #
D	JK	04/15	RT28028
E	TJ	97/06	RT28017
F	YJ	87/95	RT28013
G	XJ, MJ	84/96	RT28027



### Parking & Sidemarker Lamp Kits

Includes: 2 Parking Lamps, 2 Sidemarkers, and 4 Amber bulbs

Model	Year	Part #
JK	07/13	RT28018
TJ	97/06	RT28015
YJ	87/95	RT28010

Note: Modifications to Parking Lamp Wiring Required for 94/95 YJ





## HIGH POWER LED ACCESSORIES

### LED Block Lamps

- Fully potted to withstand the rigors of outdoor use
- Universal design — Easy to mount anywhere
- 5,000K Color Temperature



Application	Description	Part #
Universal	Single 4" Lamp with Wiring Harnesses	RT28030
Universal	Dual Light Wiring Harness for Mounted Lights	RT28031
07/15 JK	4" Lamps with Wiring Harness & Windshield Light Mount Brackets	RT28032
97/06 TJ	4" Lamps with Wiring Harness & Windshield Light Mount Brackets	RT28073
87/95 YJ	4" Lamps with Wiring Harness & Windshield Light Mount Brackets	RT28074

### LED Light Bars

- 15° focus lenses
- 5,000K Color Temperature
- High quality NICHIA LEDs to accomplish high LUMEN output with 5 watts per LED



Application	Description	Part #
07/15 JK	20" Bar with #2285 Hood Bracket Kit	RT28033
07/15 JK	50" Bar with #2180 Roof Bracket Kit	RT28034
Universal	License Plate Bracket with 10" LED Bar	RT28035





### LED Fog Lamp Assemblies - PAIR

- Fully compatible OEM harness for plug and play
- Utilizes existing fog lamp housing for an OEM installation; Adjustable design
- Black coated stainless steel hardware and fasteners included
- CNC 6061 aluminum housing

Application	Comment	Part #
07/15 JK w/ OE Bumper	With H16 Harness	RT28036
11/15 JK w/ Steel Bumper	With H16 Harness	RT28037
07/15 JK	With H10 Harness	RT28038

### LED Grilles

- Cut-to-Fit design to give a Jeep® a true makeover
- With 20" LED Light Bar

Application	Construction	Part #
07/15 JK	CNC Billet Aluminum	RT28040
07/15 JK	Black Powdercoated Stainless Steel	RT28041

### LED Headlamps - PAIR

- 7" Headlights
- Each pair outputs 12,000LM
- 5,000K color temperature
- CNC 1" 6061 aluminum

Application	Part #
07/15 JK	RT28039

### LED Dome Lights

Application	Part #
07/15 JK 2-Door	RT28042
07/10 JK 4-Door	RT28044
11/15 JK 4-Door	RT28043



#### Highest Rated LED Bars (certified by an independent lab):

- MIL-STD-810G, method 514.6 – vibration
- MIL-STD-810G, method 511.5 – explosive atmosphere testing
- IP68 – dust and immersion
- ASTMB 117 – salt and fog
- IP69K – dust IP6 and high pressure water spray

## LED BULBS



## LED Miniature Bulbs - PAIR

Application	Description	Part #
Universal	194 - Amber	RT28062
Universal	194 - Cool White	RT28063
Universal	194 - Red	RT28064
Universal	3157 - Amber	RT28065
Universal	3157 - Red	RT28066
Universal	3157 - White	RT28067
Universal	921 - Red	RT28068
Universal	921 - White	RT28069
Universal	1157 - Amber	RT28070
Universal	1157 - Red	RT28071
Universal	1157 - White	RT28072

## LED Fog Lamp Bulbs - PAIR

Application	Description	Part #
Universal	H16	RT28045
Universal	H3	RT28046
Universal	H10	RT28047
Universal	9006	RT28048
Universal	PSX24	RT28049

**LED Headlight Kits - PAIR**

Application	Description	Part #
Universal	H3	RT28050
Universal	H4	RT28051
Universal	H7	RT28052
Universal	H10	RT28053
Universal	H16	RT28054
Universal	H1	RT28055
Universal	H13	RT28056
Universal	9004	RT28057
Universal	9005	RT28058
Universal	9006	RT28059
Universal	9007	RT28060
Universal	PSX24W	RT28061



RT28053



RT28054



## WHEEL SPACER KITS

Achieve an aggressive look and improved stability with RT Off-Road's Wheel Spacer and Wheel Spacer Adapter kits. These Wheel Spacers and Adapters are an affordable option for additional backspacing or conversion to a more popular bolt pattern. All of RT Off-Road's Wheel Spacers and Adapters are constructed of 1.5" thick 6061 T6 Aluminum. Each set has a hub-centric and wheel-centric design to ensure proper fitment on applications. All Spacers and Adapters are anodized blue to ensure a long lasting finish. RT Off-Road Spacer and Adapter sets are sold complete with 10 Lug Nuts, grade 8 Studs, and thread locking compound.

Model	Year	Comments	Part #
JK	07/15	5 on 5" Bolt Pattern	RT32004
TJ	97/06	5 on 4.5" Bolt Pattern	RT32003
YJ	87/95	5 on 4.5" Bolt Pattern	RT32003
XJ	84/01	5 on 4.5" Bolt Pattern	RT32003
MJ	86/92	5 on 4.5" Bolt Pattern	RT32003
KJ	02/07	5 on 4.5" Bolt Pattern	RT32003
KK	08/10	5 on 4.5" Bolt Pattern	RT32003
ZJ	93/98	5 on 4.5" Bolt Pattern	RT32003
WJ, WG	99/04	5 on 5" Bolt Pattern	RT32004
WK, WH	05/10	5 on 5" Bolt Pattern	RT32004
XK, XH	06/10	5 on 5" Bolt Pattern	RT32004
CJ	76/86	5 on 5.5" Bolt Pattern; 4.2" Center Bore	RT32005

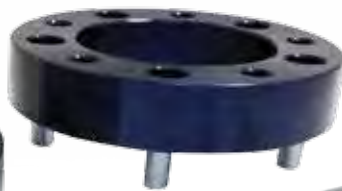

RT32005



## WHEEL ADAPTERS

RT Off-Road's Wheel Adapter Kits are a perfect solution for anyone wanting to expand their wheel choice. They allow the use of any 5 on 5" wheel to be installed on any vehicle with a 5 on 4.5" bolt pattern (example JK wheels on a TJ). They start as a 1.5" thick piece 6061 T6 aluminum. They are then machined and anodized blue for corrosion resistance. From there, Grade 8 studs are pressed into the Adapters. Each set includes 2 Spacers, 10 Lug Nuts, and thread locking compound.

### 5 on 4.5" to 5 on 5" Adapters

Model	Year	Part #
TJ	97/06	RT32001
YJ	87/95	RT32001
XJ	84/01	RT32001
MJ	86/92	RT32001
KJ	02/07	RT32001
KK	08/12	RT32001
ZJ, ZG	93/98	RT32001

### 5 on 4.5" to 5 on 5.5" Adapters

Model	Year	Part #
TJ	97/06	RT32002
YJ	87/95	RT32002
XJ	84/01	RT32002
MJ	86/92	RT32002
KJ	02/07	RT32002
KK	08/12	RT32002
ZJ, ZG	93/98	RT32002



## NUT PLATE KIT

For Skid Plate And/Or Tow Hitch Mounting.  
Kit includes 1 left and 1 right reinforcement Nut Plate to mount a Gas Tank Skid Plate or Tow Hitch when factory Nut Plate is missing or damaged.

Model	Year	Replaces Part #
XJ	84/01	52001174K



## AIR SCOOP

Increase the efficiency of the heater and air conditioner and improve airflow through the vents with this dark smoke acrylic air scoop. No drilling required.

Model	Year	Part #
TJ	97/06	RT26001
YJ	87/95	RT26001
CJ	76/86	RT26001



## JERRY CANS

RT Off-Road's 5.4 gallon metal cans include a plastic pour spout, vent, and a travel cap. The painted steel construction can easily be painted a custom color or used as it is received (Red or Olive colored). UN and Canada Approved. US Forest Service accepted. Universal Mount, Part #D8007 (Zinc Finish and Lockable), Sold Separately.

Description	Part #
Red Jerry Can	RT26010
Olive Jerry Can	RT26009



### Replacement Parts for Jerry Cans

Description	Part #
Cap	RT26011
Vent Cap	RT26014
Spout	RT26013
Mounting Bracket	RT26012



RT26011



RT26014



RT26012



RT26013

### Blue Water Can

RT Off-Road's Blue Water Can is constructed of powder coated steel with a food-grade liner to prevent contamination of the liquid inside. The top features an o-ring and a lock pin to prevent leakage even in the most intense, off-camber situations.

- Powder Coated Blue
- Food-Grade Liner
- O-Ring Cap w/ Locking Pin
- Will work with traditional Jerry can mounts

Description	Part #
Blue Water Can	RT26020



## TRAIL CAN UTILITY TOOL BOX



RT Off-Road's Tool Storage can is a great way to uniquely store a vehicle's gear. This Storage Can has the same finish and dimensions as a standard 5 gallon Jerry can (18x13x6.5"). The Storage Can contains two removable drawers and one lift out tray. These trays and drawers are kept safe under the built in lock and key. The all steel construction is kept safe with a durable red powder coated finish.

Model	Part #
All Vehicles	RT26019

## HOLDERS



### For Fire Extinguisher

Handy Fire Extinguisher Holder attaches to any roll bar or sports bar up to 3" diameter. Holds a 3 lb. extinguisher (not included). Attaches with adjustable hook and loop straps. Available in red only.

Model	Part #
All Vehicles	RT27005



### For Flashlight

Hook and loop straps are used to affix to any roll bar up to 3". Uses a single hook and loop strap to quickly remove any D-Cell flashlight.

Model	Part #
All Vehicles	RT27043



### For Cups

Includes a pair of insulated drink holders designed to hold a variety of bottles and can sizes. They mount via hook and loop straps to any vehicle with roll bars up to 3"

Model	Part #
All Vehicles	RT27044





## DOOR GRAB HANDLES

- Fits all models including Rubicon and Unlimited
- Fits both half and full steel doors
- Includes 2 Handles
- Black nylon / rubber construction

Model	Year	Part #
JK	07/15	RT27046
TJ	97/06	RT27017
YJ	87/95	RT27004
CJ-5, 7, 8	76/86	RT27004



## GRAB BAR SETS

These deluxe handles feature molded rubber grips with heavy duty vinyl straps. They have a three loop design with heavy duty hook and loop straps to secure them to a roll bar. Sold in pairs.

Model	Part #
All Vehicles	RT27007



These economy handles have a soft vinyl foam grips. They have an adjustable two loop design to secure them to a roll bar. Sold in pairs.

Model	Part #
All Vehicles	RT27006



## DELUXE LOCKING CENTER CONSOLES

Features: front and rear cup holders, spring action coin organizer, extra large armrest, removable cooler that holds a six-pack, large locking storage area for CD's and valuables, and a concealed sunglasses holder.

Model	Year	Color	Part #
YJ	87/95	Gray	RT27008
YJ	87/95	Spice	RT27010
YJ	87/95	Black	RT27009
CJ	76/86	Gray	RT27008
CJ	76/86	Spice	RT27010
CJ	76/86	Black	RT27009



## ROCK KEY BLANK

These rugged looking keys are licensed replacements for stock Jeep keys. They compliment the Jeep's famous "trail-rated" capabilities.



Model	Year	Comment	Part #
TJ	98/05	Transponder	RT27011
TJ	97/06	Non-Transponder	RT27013
YJ	94/95	Non-Transponder	RT27013
XJ	98/01	Transponder	RT27011
XJ	94/01	Non-Transponder	RT27013
ZJ	94/98	Non-Transponder	RT27013
WJ	99/04	Transponder	RT27011
WJ	99	Non-Transponder	RT27013
KJ	02/04	Transponder	RT27011
KJ	02/04	Non-Transponder	RT27013
XK	06/07	Transponder	RT27012

## LED SUPERBRIGHT UTILITY LIGHT

Universal application. Attaches to roll bar with hook and loop straps. Light also has a magnetic strip that will attach to metal when removed from the hook and loop strap. Takes 3 AAA batteries, not included.

Model	Part #
All Vehicles with Rollbars	RT28007



## STORAGE DASH TRAYS

Model	Year	Color	Part #
JK	07/10	Black	RT27022
TJ	97/06	RT27016	



RT27016



RT27022

## CLINOMETERS

RT Off-Road's new clinometers are an awesome way of ensuring that passengers are safer while off-road. They include a roll gauge which will tell how off-camber the vehicle is at all times, along with a pitch gauge which will show how steep of an incline or decline is being conquered. These clinometers are easy to install and adjust using the included adhesive backed base. Fits all vehicles.

Description	Part #
Roll and Pitch Gauge with CJ Graphics	RT27003
Roll, Pitch Gauge and Compass with JK Wrangler™ Graphics	RT27045



RT27003



RT27045



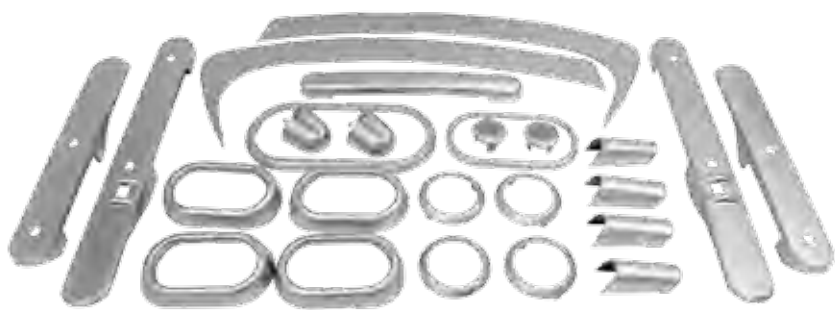

RT27032



RT27038



RT27021



RT27040



RT27042



RT27028



RT27024



RT27035



RT27036



RT27026

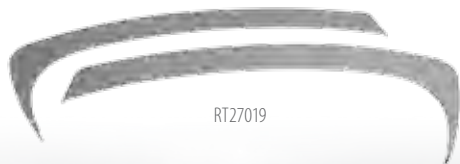

RT27019

## INTERIOR TRIM PIECES FOR JK WRANGLER™

RT Off-Road's Interior Trim pieces add a distinctive look to the 2007-2010 JK Wranglers. These trim accents install in minutes with double sided tape or by snapping in place. Each piece is constructed out of durable injection molded plastic and finished in either chrome or brushed silver. Trim pieces are available in a complete kit or individually.

### Chrome

Description	Part #
Complete Kit 2 Door	RT27029
Complete Kit 4 Door	RT27032
Shifter Bezel	RT27037
Steering Wheel Spokes	RT27039
A/C Vent Cover (2)	RT27027
Speaker Cover (2)	RT27041
Cup Holder Trim	RT27020
Grab Handle Cover	RT27025
Rear Door Handle Covers (2)	RT27033
Front Door Handle Covers (2)	RT27034
Door Handles (2)	RT27023
Center Console	RT27018

### Silver

Description	Part #
Complete Kit 2 Door	RT27031
Complete Kit 4 Door	RT27032
Shifter Bezel	RT27038
Steering Wheel Spokes	RT27040
A/C Vent Cover (2)	RT27028
Speaker Cover (2)	RT27042
Cup Holder Trim	RT27021
Grab Handle Cover	RT27026
Rear Door Handle Covers (2)	RT27035
Front Door Handle Covers (2)	RT27036
Door Handles (2)	RT27024
Center Console	RT27019



## FRONT BUMPERS

Replace a dented or rusty factory front bumper with an RT Off-Road Stainless Steel Front Bumper. Each bumper is manufactured of stainless steel and then polished to a brilliant finish. Bumper includes all the bolt holes necessary to mount it to the vehicle and requires no drilling. It also includes the same factory hole locations to mount the factory bumper end caps.



A



B



C



D



E



F

### Stainless Steel

Image	Model	Years	Part #
A	TJ	97/06	RT34051
B	YJ	87/95	RT34037 *
C	YJ	87/95	RT34038
D	CJ	55/86	RT34022 *
E	CJ	55/86	RT34023

\* 54" Stainless Steel Front Racing Bumper with Holes

### Chrome

Image	Model	Years	Part #
F	TJ	97/06	RT20011 *

\* USA Only

## REAR BUMPERS

### Stainless

Image	Model	Years	Part #
A	TJ	97/06	RT20022

### Chrome

Image	Model	Years	Part #
B	TJ	97/06	RT20012 *

\* USA Only

## CORNER GUARDS

Stainless, Set of Two

Model	Years	Part #
YJ	87/95	RT34041



## ROCKER PANEL SIDE PLATE SETS

Stainless; Includes Left and Right Panel.

Image	Model	Years	Part #
A	TJ	97/06	RT34062 *
B	YJ	87/95	RT34046

\*Without Unlimited

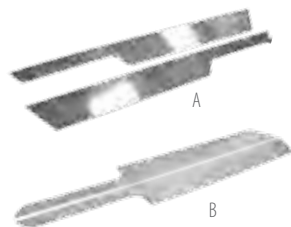

## BUMPER OVERLAYS

Cover a dented or rusty factory front bumper with an RT Off-Road Stainless Steel front bumper overlay. Each bumper overlay is manufactured of stainless steel and then polished to a brilliant finish. Bumper overlay includes all the bolt holes necessary to mount it to the vehicle and requires no drilling.

### Front

Image	Model	Years	Part #
A	TJ	97/06	RT34052
B	YJ	87/95	RT34039
C	CJ	76/86	RT34024

### Rear

Image	Model	Years	Part #
D	YJ	87/95	RT34040
E	CJ	76/86	RT34025

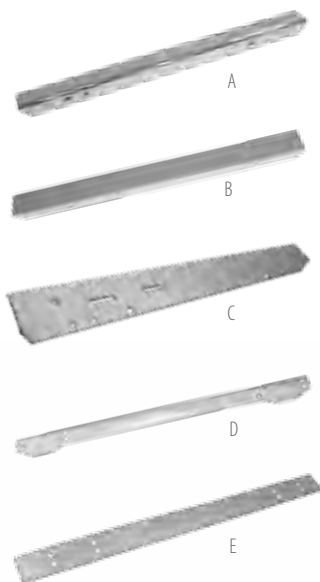

## BUMPERETTES

RT Off-Road's Bumperettes are constructed out of a highly polished stainless steel and include stainless steel fasteners. These Bumperettes mount in place of the factory pieces and include all hardware needed for installation. Kit includes driver and passenger side Bumperettes and all hardware needed for installation.

Model	Years	Color	Part #
YJ, CJ	76/95	Stainless	RT20020



## FRONT FRAME COVERS

Image	Model	Years	Color	Part #
A	TJ	97/06	Stainless	RT34045
B	YJ	87/95	Stainless	RT34043
C	CJ	76/86	Stainless	RT34030

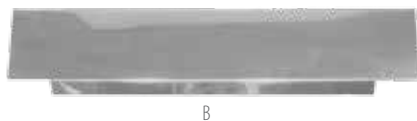
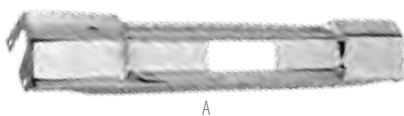
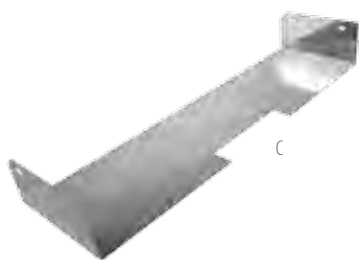



## ENTRY GUARDS SETS

Model	Comment	Color	Years	Part #
JK	2DR	Stainless	07/15	RT34072
JK	2DR	Black	07/15	RT26049
JK	4DR	Stainless	07/15	RT34073
JK	4DR	Black	07/15	RT26050
TJ		Stainless	97/06	RT34053
TJ		Black	97/06	RT26036
YJ & CJ-7		Stainless	76/95	RT34010
YJ & CJ-7		Black	76/95	RT34010
CJ-5		Stainless	55/83	RT34028



RT34028

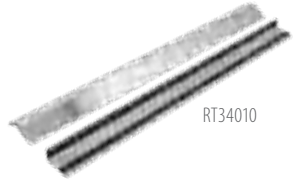

RT34010



RT26036



RT26050



RT34073



RT26050

## VEHICLE RECOVERY KIT

The RT Off-Road Vehicle Recovery kit is the most convenient collection of recovery parts available. This kit contains everything needed to complete a complex winching operation as well as individual items that will aid in more simple situations. All items are stowed away in a heavy duty polyester bag. Be prepared and have the right tools ready for vehicle recovery.

- Includes: Recovery Strap, Tree Saver, Snatch Block, Two D-Rings, Winch Line Dampener, Gloves, and a Recovery Bag
- The Recovery Tow Strap is rated for 20,000 lbs. and features leather-wrapped ends.
- The Tree Saver is rated for 30,000 lbs. and is used to guarantee the well-being of trees when recovering with a winch.
- Leather-Palmed Gloves and a winch line dampener are added to ensure the safety of all persons using this kit.
- The Recovery bag is oversized to accommodate for storage of additional accessories.

### Description

Complete Vehicle Recovery Kit

### Part #

RT33013



## D-RING AND RECEIVER KITS

RT Off-Road's recovery accessories are a high quality, high value, collection of products. Designed and produced to ensure a strong, safe, and durable point to recover or couple. All metal recovery products are either powder coated black or zinc finished to protect the product for years of use.

All Receivers are 2" and D-Rings are 3/4" unless stated

Description	Part #
Stainless Steel D-Ring	RT33002
Zinc Plated Steel D-Ring	RT33001
5/8" Stainless Steel D-Ring	RT33003
1 Receiver and 3 D-Rings	RT33011
1 Receiver and 2 D-Rings	RT33010
1 Receiver and 1 D-Ring	RT33009
2 D-Rings	RT33005



### Rubber Spacers For D-Rings

Eliminates Rattle

Description	Part #
1 Rubber Spacer	RT33007
2 Rubber Spacers	RT33008
1 Stainless Steel D-Ring with spacers	RT33004
1 Receiver and 1 D-Ring with spacers	RT33014
2 D-Rings with spacers	RT33006



## TOW HOOK KITS

Model	Years	Color	Part #
CJ-5, 6, 7, 8	55/86	Chrome	RT33014
CJ-5, 6, 7, 8	55/86	Black	RT33015



## FUEL DOORS

Finish the look of a vehicle with RT Off-Road's Fuel Door. Available in both brushed, polished, or black powder coated aluminum. Available with or without lock mechanism. Includes all hardware needed for installation

Model	Years	Color	Comment	Part #
JK	07/15	Black	Non-Locking	RT26053
JK	07/15	Black	Locking	RT26054
JK	07/15	Polished Aluminum	Non-Locking	RT26051
JK	07/15	Polished Aluminum	Locking	RT26052
TJ	97/06	Black	Non-Locking	RT26037
TJ	97/06	Black	Locking	RT26040
TJ	97/06	Polished Aluminum	Non-Locking	RT26038
TJ	97/06	Polished Aluminum	Locking	RT26039

RT26051



RT26053



RT26052



RT26054



## FUEL NECK PROTECTORS

Image	Model	Years	Color	Part #
A	TJ	97/06	Stainless	RT34056
B	YJ, CJ-5, 7, 8	78/95	Stainless	RT34089

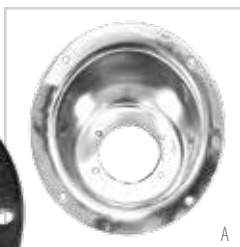

A



B



RT34008



RT34009



RT34071



RT34070

## DOOR HINGE SETS

RT Off-Road's Stainless Steel products offer optimal fit and finish while maintaining superior function. All Brackets, Hinges, and hardware are produced from corrosion resistant stainless steel. Each part is available in either a polished stainless steel or a rich black powder coat.

Model	Color	Comments	Years	Door	Part #
JK 2-Door	Stainless	4 Hinges	07/15	Full or Half	RT34071
JK 4-Door	Stainless	8 Hinges	07/15	Full or Half	RT34079
JK 2-Door	Stainless	4 Body Hinges	07/15	Full or Half	RT34070
JK 4-Door	Stainless	8 Body Hinges	07/15	Full or Half	RT34069
TJ	Black	4 Hinges	97/06	Full or Half	RT34094
TJ	Stainless	4 Hinges	97/06	Full or Half	RT34009
YJ	Black	4 Hinges	87/95	Full	RT34093 *
YJ	Stainless	4 Hinges	87/95	Full	RT34008 *
YJ	Black	4 Hinges	87/95	Half	RT34094 *
YJ	Stainless	4 Hinges	87/95	Half	RT34009 *
CJ-5, 7, 8	Black	4 Hinges	76/86	Full or Half	RT34093
CJ-5, 7, 8	Stainless	4 Hinges	76/86	Full or Half	RT34008

\* With Provisions for Mirrors

**Lower Door Hinge Brackets**

Model	Color	Years	Part #
TJ	Stainless	97/06	RT34007
TJ	Black Stainless	97/06	RT34092
YJ	Stainless	87/95	RT34007
YJ	Black Stainless	87/95	RT34092
CJ-5, 6, 7, 8	Stainless	55/86	RT34007
CJ-5, 6, 7, 8	Black Stainless	55/86	RT34092

**DOOR HANDLES**

- Stainless Steel Construction
- Highly polished finish
- Fits Full or Half Doors on: 07/15 JK Wrangler,<sup>™</sup> 08/12 KK Liberty,<sup>™</sup> 07/09 KA Dodge Nitro.<sup>™</sup> Also fits JK Tailgate.
- Includes all hardware needed for installation.

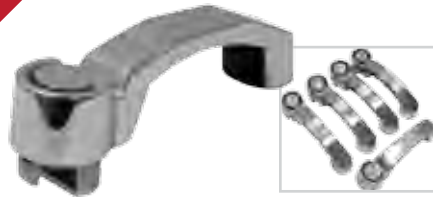

Quantity	Comment	Part #
1	Individual	RT34002
2	2-Door	RT34003
3	2-Door Plus Tailgate	RT34004
4	4-Door	RT34005
5	4-Door Plus Tailgate	RT34006



## TAILGATE HINGE SETS

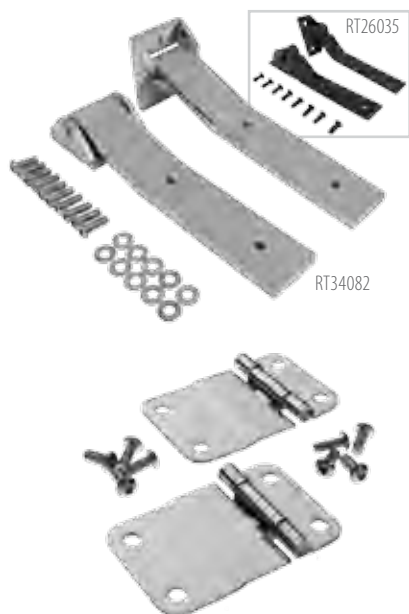

Replace those old, rusty Tailgate Hinges with a set from RT Off-Road. Each set is manufactured out of stainless steel and then polished to a brilliant finish. Stainless steel hardware is included.

Model	Color	Years	Part #
JK	Stainless	07/15	RT34082
TJ	Stainless	97/06	RT34065
YJ	Stainless	87/95	RT34049
YJ	Black	87/95	RT26035

### Lower Tailgate Hinge Sets

RT Off-Road's Tailgate Hinges offer an optimal fit and finish while maintaining superior function. Tailgate Hinges and all hardware are produced from corrosion resistant stainless steel.

Model	Color	Years	Part #
CJ-7, 8	Stainless	76/86	RT34035



## LIFTGATE HINGE SETS

RT Off-Road's Liftgate Hinges offer an optimal fit and finish while maintaining superior function. Lower Tailgate Hinges and all hardware are produced from corrosion resistant stainless steel.

Model	Color	Years	Part #
CJ-7	Stainless	77/86	RT34032



## TAILGATE TIRE STOP

Replace that old, rusty Tailgate Tire Stop with one from RT Off-Road. Manufactured out of stainless steel. All hardware included.

Model	Color	Years	Part #
YJ, CJ-7, 8	Stainless	76/95	RT34015
YJ, CJ-7, 8	Black	76/95	RT26018





**HOOD HINGE SETS**



RT34076

Model	Color	Years	Part #
JK	Stainless	07/15	RT34076 *
JK	Stainless	07/15	RT91002
TJ	Stainless	97/06	RT34057
TJ	Black	97/06	RT34091
YJ	Stainless	87/95	RT34012
YJ	Black	87/95	RT34095
CJ-5, 6, 7, 8	Stainless	55/86	RT34012
CJ-5, 6, 7, 8	Black	55/86	RT34095

\* Includes: 1 Footman Loop and 2 Hood Stops

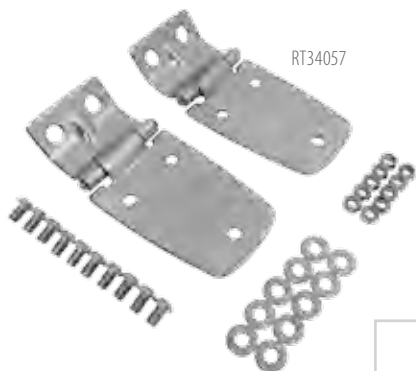

RT34057

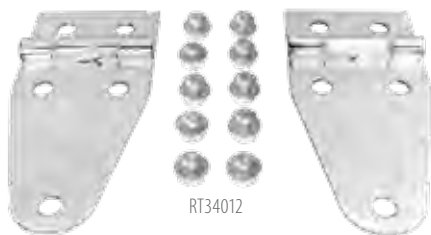

RT34012



RT34091

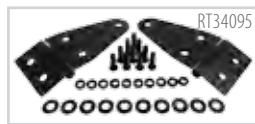

RT34095

## HOOD VENT COVERS

Model	Years	Color	Part #
JK	07/15	Stainless	RT34078
TJ	1997	Stainless	RT34060
TJ	98/06	Stainless	RT34061
YJ, CJ-5, 7, 8	78/95	Stainless	RT34014
YJ, CJ-5, 7, 8	78/95	Black	RT26008
CJ-5, 6	55/75	Chrome	RT26024



RT34078

## COMPLETE HOOD SETS

Model	Years	Color	Part #
JK	07/15	Stainless	RT34077
TJ	1997	Stainless	RT34058
TJ	98/06	Stainless	RT34059
YJ	87/95	Stainless	RT34013
YJ	87/95	Black	RT26007
CJ-5, 7, 8	78/86	Stainless	RT34013
CJ-5, 7, 8	78/86	Black	RT26007

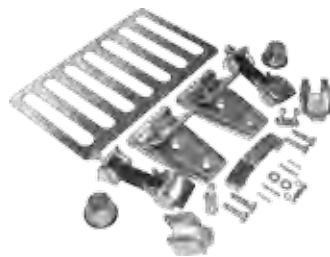

RT34077



RT34013



## HOOD CATCH KITS

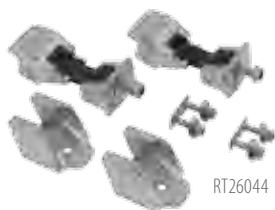

Improve the look of any Jeep with RT Off-Road's Hood Catch Kit. This kit is designed to bolt in place of the OE hood catches. All necessary hardware is included for installation.

Single; fits left or right, Two required.

Model	Years	Color	Part #
YJ, CJ	41/95	Chrome	RT26006
YJ, CJ	41/95	Stainless	RT26005

Pairs; fits left and right.

Model	Years	Color	Part #
JK	07/15	Stainless	RT34075
TJ	97/06	Stainless	RT26044
YJ, CJ	55/95	Stainless	RT34083 *
YJ, CJ	55/95	Black	RT34084 *
YJ, CJ	41/95	Stainless	RT34011

\* Modern Style

### Locking

Bolt on security for the engine compartment and under hood accessories with a Locking Hood Catch Kit from RT Off-Road. Included with each kit is a pair of black powder coated 304 stainless steel Hood Catches, a set of pre-installed lock cylinders with keys, and all necessary hardware. Hood flutter, a very common problem with all Jeep JK's, is eliminated by omitting rubber from the construction of the kit. This kit fits in place of the factory hood catches; a no-drill installation.

Model	Years	Color	Part #
JK	07/15	Black	RT26057

Bolt on security for the engine compartment and under hood accessories with RT Off-Road's Hood Lock. Complete system installs easily to the vehicle's security latch. Lock assembly comes complete with two keys.

Model	Years	Color	Part #
TJ	1997	Black	RT26070
TJ	97/06	Silver	RT26071
YJ	87/95	Black	RT26069

## CHROME GRILLE COVERS

- Stainless Steel Construction.
- Fits all available models.
- Installs directly over factory grille using double face tape and screws.

Model	Years	Part #
YJ	87/95	RT34044
YJ	87/95	RT34045 *
CJ	72/86	RT34031 *
CJ	72/86	RT34086

\* Includes Chrome Headlight Bezels

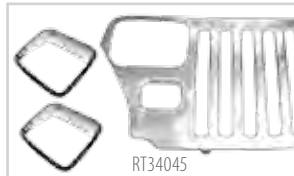
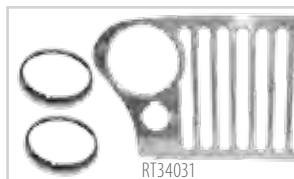

## GRILLE INSERTS

Complete the factory grille's look with RT Off-Road's Grille Inserts. Every Grille Insert set includes seven primary inserts that either snap or bolt into place. All kits are sold complete and include everything you need for installation.

Model	Years	Color	Part #
JK	07/15	Stainless	RT34074
JK	07/15	Chrome Plastic	RT26055
JK	07/15	Black	RT26056
TJ	97/06	Chrome Plastic	RT26042
TJ	97/06	Black	RT26043
YJ	87/95	Chrome Plastic	RT26030
YJ	87/95	Black	RT26031



RT26055



RT26056



RT34074



## BUG SCREENS



RT34021



RT26023



RT34050



RT34036

Model	Years	Color	Part #
TJ	97/06	Stainless	RT34050
TJ	97/06	Black	RT34085
YJ	87/95	Stainless	RT34036
YJ	87/95	Black	RT26029
CJ	55/86	Stainless	RT34021
CJ	55/86	Black	RT26023

## STONE GUARD SETS

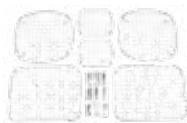

RT26032



RT334064

Model	Years	Color	Part #
TJ	97/06	Stainless	RT34064
TJ	97/06	Chrome	RT26047
YJ	87/95	Stainless	RT34047
YJ	87/95	Chrome	RT26032
YJ	87/95	Black	RT26033
CJ	76/86	Stainless	RT34034
CJ	76/86	Chrome	RT26032

## BILLET STYLE STONE GUARD SETS

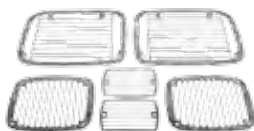

RT34048

Model	Years	Color	Part #
TJ	97/06	Stainless	RT34063
TJ	97/06	Black	RT26048
YJ	87/95	Stainless	RT34048
YJ	87/95	Black	RT26034

## EURO GUARDS

- 6 Piece Kit For Front Lamps
- Includes Guards For: Headlamps, Parking Lamps, And Sidemarkers Lamps

Model	Years	Color	Part #
TJ	97/06	Stainless	RT34054



## TAIL LIGHT GUARDS SETS

### Euro Style

Model	Year	Color	Part #
JK	07/15	Black	RT28002
TJ	97/06	Black	RT26017
TJ	97/06	Stainless	RT34090
TJ	97/06	Titanium	RT34098
YJ	87/95	Black	RT26017
YJ	87/95	Stainless	RT34090
YJ	87/95	Titanium	RT34098
CJ	76/86	Black	RT26017
CJ	76/86	Stainless	RT34090
CJ	76/86	Titanium	RT34098

### Traditional Style

Model	Year	Color	Part #
JK	07/15	Stainless	RT34080
JK	07/15	Stainless	RT34081

\* Includes Hardware



RT26017



RT34090



RT28002



RT34081



RT34080



## WINDSHIELD HINGE SETS



RT34066

RT34096

RT34017

Model	Color	Years	Part #
TJ	Stainless	97/06	RT34066
YJ, CJ	Black	55/95	RT34096
YJ, CJ	Stainless	76/95	RT34017

## LIGHT BARS



RT28009



RT28008



RT28014

Model	Years	Color	Part #
TJ	97/06	Stainless	RT28014
YJ	87/95	Stainless	RT28008
YJ	87/95	Stainless	RT28009
CJ	76/86	Stainless	RT28008
CJ	76/86	Stainless	RT28009



## WINDSHIELD TIE DOWN KITS

- Stainless Steel Construction
- Highly polished, corrosion resistant finish
- Includes all hardware needed for installation

Model	Years	Color	Part #
JK	07/15	Stainless	RT34097 **
TJ	97/06	Stainless	RT34068 *
YJ	87/95	Stainless	RT34019
YJ	87/95	Black	RT26022
CJ	55/86	Stainless	RT34019
CJ	55/86	Black	RT26022

\* Includes two windshield bumper bezels, two wiper nozzle bezels, and one footman loop; Bezels and wiper nozzles attach with double sided tape and are constructed out of plastic

\*\* Includes two windshield bumpers, one hood mounted footman loop, and all hardware needed for install; Will also fit all 1997-2006 TJ Wrangler Models



RT34019



RT34068



RT34097

## STAINLESS STEEL FOOTMAN LOOP SETS

Model	Year	Part #
CJ	55/86	RT34029

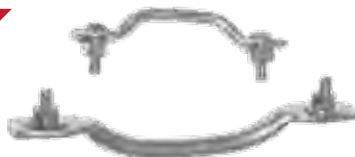

## WINDSHIELD LIGHT MOUNT BRACKET SETS

Easily add auxiliary lights with RT Off-Road's Windshield Light Mount Brackets. Brackets mount to the vehicle using existing holes in the windshield frame. Each set is finished in a rich gloss black powder coat. Kit includes all hardware needed for installation. An antenna bracket and grommet is also included to eliminate any possibility of the antenna contacting the lights.

RT28003



Model	Color	Years	Part #
JK	Black	07/15	RT28003
TJ	Stainless	97/06	RT34067
TJ	Black	97/06	RT28001
YJ, CJ	Stainless	76/95	RT34018
YJ, CJ	Black	76/95	RT26021



## MIRROR RELOCATION BRACKET SETS

Remove the doors from a Jeep without removing mirrors with RT Off-Road's Mirror Relocation Brackets. In this kit is a pair of brackets that installs into existing holes in the windshield frame. A pair of door inserts are also included to cover the holes from the moved bracket on JK models. Both the brackets and the inserts are finished in a rich black powder coat.

Model	Color	Years	Part #
JK	Black	07/15	RT30016
TJ	Black	97/02	RT30013
TJ	Stainless	97/02	RT300015
TJ	Black	03/06	RT300014
YJ	Black	87/95	RT30010

RT30016



RT300015



RT30010



RT30013



RT300014



## MIRRORS



Replaces Part #  
82200834CK

### Door Mounted

Model	Color	Years	Comments	Replaces Part #
TJ, YJ	Chrome	87/06	Set, 87/02 Style	82200834CK

### Front Windshield Hinge Mounting

Model	Color	Years	Comment	Part #
YJ	Stainless	87/95	Set	RT30003
CJ	Stainless	55/86	Set	RT30003



RT30003

### Side Windshield Hinge Mounting

Model	Color	Years	Comments	Part #
TJ	Stainless	97/06	Set	RT30011
TJ	Black	97/06	Set	RT30012
YJ, CJ	Stainless	76/95	Set	RT30001
YJ, CJ	Black	76/95	Set	RT30002



RT30011



RT30012

### Safari Mirror

RT Off-Road's Safari Mirrors are a great solution for those who want to drive without doors, but require side view Mirrors. These black powder coated Mirrors mount directly to the body side of the door hinge and tighten with the supplied hardware. They are adjustable to change the angle of the Mirror for use on either side of the vehicle. Each kit includes two 8"x6" Mirrors, two Arms, and all hardware needed to mount them to the vehicle.

Model	Color	Years	Replaces Part #
JK, TJ, YJ	Black	87/15	RT30004 *
JK, TJ, YJ	Black	87/15	RT30005
CJ	Black	76/86	RT30004 *
CJ	Black	76/86	RT30005

\* Single; One mirror, one arm, and hardware.



### Quick Release Mirror Set

RT Off-Road's Quick Release Mirrors are a great solution for those who want to drive without doors, but require side view Mirrors. The gloss black powder coated brackets mount directly to the side of the upper windshield hinge. The included Mirror Arms and Heads attach to the Brackets with a thumb screw to allow for a quick release. Each kit includes two 6" round Mirrors, two Arms, two Brackets, and all hardware needed to mount it to the vehicle.

Model	Color	Years	Replaces Part #
JK, TJ, YJ	Black	87/15	RT30020
CJ	Black	76/86	RT30020





## INTERIOR WINDSHIELD BRACKET SETS

Model	Years	Color	Part #
YJ, CJ	76/95	Stainless	RT34016
YJ, CJ	76/95	Black	RT27014

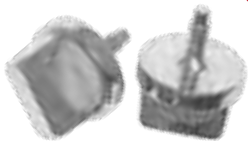

## WINDSHIELD KNOB SET

Model	Years	Color	Comments	Part #
CJ	76/86	Chrome	Set of 2	RT26028



## DASH KNOB SETS

Finish the look of a vehicle's dash with RT Off-Road's Dash Control Knob Set. Available in both polished and powder coated aluminum. Install in place of the factory plastic knobs and are held in place with set screws. Includes all hardware needed for installation.

Model	Years	Color	Part #
CJ	76/86	Black	RT27002
CJ	76/86	Aluminum	RT27001



## BILLET SHIFT KNOBS

RT Off-Road's polished billet aluminum Shift Knob offer optimal fit and finish while maintaining superior function. All our Shift Knobs and hardware are produced from corrosion resistant aluminum that is polished to a mirror finish. The Aluminum knob installed in place of the factory piece and will include all hardware needed for installation.

Model	Year	Color	Description	Part #
TJ, YJ	87/98	Aluminum	NP231 Shift Pattern, M10 - 1.5	RT24009
TJ, YJ	87/98	Aluminum	5 Speed Shift Pattern, 3/8" - 16	RT24008 *
TJ, YJ	94/06	Aluminum	5 Speed Shift Pattern, M10 - 1.5	RT24007

\* See part 46009 for matching transfer case shift knob for 1987-1995 Wrangler



## STAINLESS STEEL DASH GRAB BARS



RT34026

Model	Years	Color	Part #
CJ	55/86	Stainless	RT34026
CJ	55/86	Black	RT27015

## STAINLESS STEEL DASH OVERLAYS

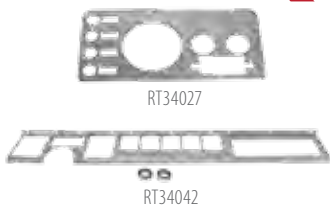

RT34027

RT34042

Model	Years	Color	Part #
YJ	87/95	Stainless	RT34042
CJ	76/86	Stainless	RT34027*

\* With Radio Opening

## STAINLESS STEEL STEERING COLUMN COVER



Model	Years	Part #
CJ	76/86	RT34033

## STAINLESS STEEL BATTERY TRAYS & ACC.



RT34087



RT34088

Model	Years	Description	Part #
CJ	76/86	Tray	RT34087
CJ	76/86	Clamp	RT34088
CJ	76/86	Tray Kit	RT34020
SJ, J-Series	76/86	Clamp	RT34088



## ALUMINUM VALVE COVER KITS

RT Off-Road's Engine Valve Cover Kit's are a direct replacement upgrade for factory valve covers. Each Valve Cover is constructed out of aluminum. Available in an assortment of colors, or in bare aluminum. Increased internal clearance allows for the use of oversized Camshafts and high clearance Rocker Arms. Each kit includes Gasket, Grommets, and additional installation hardware.

- Durable finish with polished fins and engine script
- Includes Valve Cover, Gasket, Oil Cap, Grommets, and Hardware
- Some modification may be required

### For all 93/04 Jeep® Vehicles with 4.0L Engine

Color	Part #
Red	RT35002
Yellow	RT35003
Black	RT35001

Note: Replacement Oil Cap available, Part # 33001016AL

### For all 81/86 Jeep® Vehicles with 4.2L Engine

Color	Part #
Non-Painted	RT35004 *
Black	RT35005 *

\* Includes: Bridges



## STAINLESS STEEL HEADER KIT

Improve exhaust flow with RT Off-Road's new Stainless Steel Header Kit for 4.0L Jeep vehicles. This manifold starts with a pair of 1/2" thick zinc-coated flanges that will provide a perfect seal to the cylinder head and downpipe. The primaries are manufactured of 1-1/2" diameter polished, mandrel-bent 304 stainless steel tubing. They meet at a 6-to-1 polished 304 stainless steel collector, which improves exhaust flow through the entire operating range of the engine. The primaries are fully welded to the flanges and collector, resulting in an extremely strong and leak-free header. The outlet of the collector is made of polished, mandrel-bent 304 stainless steel; this time with a 2-1/2" diameter, which will mate to the stock downpipe with no issues. These features result in increased horsepower, torque, throttle response, and fuel mileage along with years of worry-free operation. Installation is straight forward with no cutting, grinding, or welding needed.

Model	Years	Part #
TJ, YJ	91/99	RT36001 *
TJ, YJ	91/99	RT36002
XJ, MJ	91/99	RT36001 *
XJ, MJ	91/99	RT36002
ZJ	93/98	RT36001 *
ZJ	93/98	RT36002

\* Kit

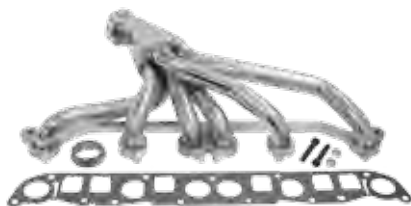

## DEEP TRANSMISSION PAN KIT

With A999 Transmission

Model	Years	Part #
YJ	87/91	RT24001
XJ, MJ	84/86	RT24001 *
SJ, J10	84/90	RT24001
CJ	80/86	RT24001 *

\* Also with A904 Transmission



## HEAVY DUTY TRANSMISSION OIL COOLER KIT

- Direct Bolt In Design
- Tube and Fin Construction
- Clean Factory Look
- Helps Prevent Transmission From Overheating

Model	Year	Part #
JK	07/11	RT24006



